

NEW

PANTECH TECHNOLOGY NOW AVAILABLE!



After more than 25 years in the market as one of the country's primary European spare parts supplier for leading bus and truck marques, Whites Diesels Australia has decided to introduce Pantech panels, also known as FRP (Fibre Reinforced Plastic panels), truck body components and complete truck bodies. A wider selection of products, to give our customers more: more service, more quality, more choice.



whitesdiesels.com.au  

CALL US
1300 657 645



Design	Code	Specifications
	MSTB1200	1.6mm steel plate toolbox with stainless steel T-handle lock , black powder coating finish 1200 x 550 x 550mm
	MSTB900	900 x 450 x 450mm
	MSTB600	600 x 430 x 450mm
	SSLTB1200	1.6mm steel plate with black powder coating and stainless steel lid , including rubber seal and stainless steel T-handle lock(s) 1200 x 550 x 550mm
	SSLTB900	900 x 450 x 450mm
	SSLTB600	600 x 430 x 450mm
	CTTB600	Steel toolbox with rubber seal & stainless steel T- handle lock 600 x 430 x 450mm Two stainless steel T-handle locks
	CTTB900	900 x 450 x 450mm
	CTTB1200	1200 x 550 x 550mm

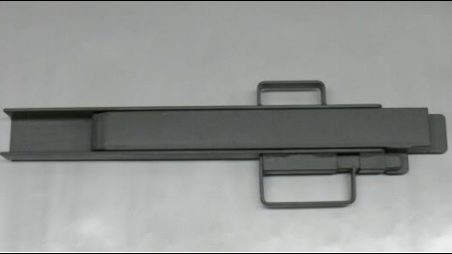

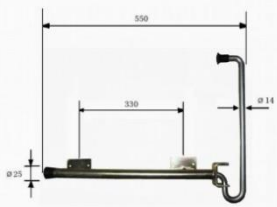
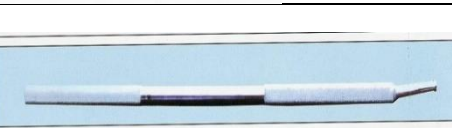

Design	Code	Specifications
	<p>SSTL-01A With fixed latch</p> <p>SSTL-01B With adjustable latch</p>	<p><i>Stainless steel T handle lock with common keys or individual keys</i></p> <p><i>Stainless steel T handle lock with common keys or individual keys</i></p> <p><i>Please advise us in your order which key you prefer.</i></p>
	<p>HACP4-3200</p> <p>HACP5-3200</p>	<p><i>Steel corner post 4mm steel plate 150x150mm profile 3200mm long</i></p> <p><i>5mm steel plate , 3200mm long</i></p>
	<p>WTCP4-3200</p>	<p><i>Steel corner post with profile and top mounting bracket fitted.</i></p> <p><i>4mm steel plate 150x150mm profile 3200mm long</i></p>
	<p>CPUD4-3200</p>	<p><i>Steel corner post 4mm steel plate 150x100mm profile 3200mm long</i></p>

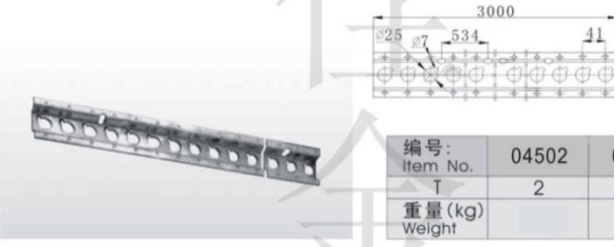
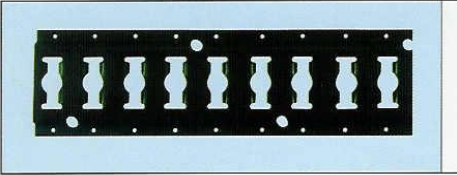
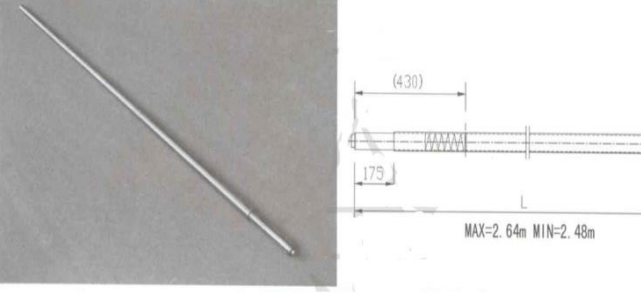
Design	Code	Specifications
	WTCW4-3200	<i>Steel centre wrap 4mm steel plate , 3200mm long Finish : powder-coating in black</i>
	CWSP-002	<i>Wrapper spigot plate- bottom 78mm in diameter</i>
	CWSP-001	<i>Wrapper spigot plate-top 78mm in diameter</i>
	CTMP-001	<i>Curtain tensioner mounting plate</i>
	CTMP-002	<i>Curtain tensioner mounting plate</i>

Design	Code	Specifications
	ACT-01L ACT-01R	<i>Aluminum alloy curtain tensioner</i> <i>Left hand or Right hand</i>
	SLBS001	<i>Sliding post base</i>
	SLTP001	<i>Sliding post roller top</i>
 <p>Door retainer for truck ART. No. : RLAB08-0101 Material: S37-2 Surface finish: zinc plated Weight: 2.500kg</p>	ZPDR-550	<i>Zinc plated door retainer</i>
	WB01	<i>Winch bar in chrome finish</i>

Design	Code	Specifications
	<p>ZRW160 We also supply straps separately</p> <p>WSH-9000</p>	<p>Zinc plated Ratchet winch 160mm wide with 50mm wide x 9mtr long strap and hook</p> <p>50 x 9mtr. Strap with hook Breaking strength 2500kg</p>
	<p>ZSW160</p>	<p>Zinc plated sliding winch 160mm wide with 50mm wide x 9mtr long strap and hook</p>
	<p>ZWT3000</p> <p>NWT3000</p>	<p>4mm thick Zinc plated winch track in 3mtr length</p> <p>4mm thick ungalvanized winch track in 3mtr length</p>
	<p>RSH-4000</p>	<p>Heavy duty ratchet tie down with 50mm x 4mtr webbing strap and keeper hooks on both ends</p>



Design	Code	Specifications										
 <table border="1" data-bbox="496 539 726 645"> <tr> <td>编号:</td> <td>04502</td> </tr> <tr> <td>Item No.</td> <td>04502</td> </tr> <tr> <td>T</td> <td>2</td> </tr> <tr> <td>重量 (kg)</td> <td></td> </tr> <tr> <td>Weight</td> <td></td> </tr> </table>	编号:	04502	Item No.	04502	T	2	重量 (kg)		Weight		CT1-6000	<p><i>Cargo Track (F track)</i> <i>Finish : Zinc plated</i></p> <p><i>Length : 6 mtr.</i></p> <p><i>Aluminum end caps also available for separate sale</i></p>
编号:	04502											
Item No.	04502											
T	2											
重量 (kg)												
Weight												
	CT2-3000	<p><i>Cargo Track (E Track)</i> <i>Finish : Zinc plated</i></p> <p><i>Length : 3 mtr</i></p>										
 <p data-bbox="544 1111 679 1133">MAX=2.64m MIN=2.48m</p>	SB1-2500	<p><i>42mm diameter Zinc plated Shoring Bar</i></p> <p><i>Adjustable length 87"-102"</i></p>										
	ETSB-4800	<p><i>16ft. Length webbing strap with hooks and buckle for E track</i></p> <p><i>Breaking load: 2T</i></p>										

Design	Code	Specifications
	<p>WTSSL-27</p> <p>WTSSH-01</p> <p>SSTB27</p>	<p><i>Stainless steel camlock</i></p> <p><i>Stainless steel hinge</i></p> <p><i>Stainless cam tube 27mm in diameter by 6m length</i></p>
	<p>WTZPL-27</p> <p>WTZPH-01</p> <p>ZTB27</p>	<p><i>Zinc plated camlock</i></p> <p><i>Zinc plated hinge</i></p> <p><i>Zinc plated cam tube 27mm in diameter by 6mtr length</i></p>
	<p>TZPH-30</p> <p>TSSH-30</p>	<p><i>Premium zinc plated hinge 30cm long x 8cm wide</i></p> <p><i>Stainless steel hinge</i></p>
	<p>ZH300</p> <p>SSH300</p>	<p><i>Zinc Plated Bolt-on Hinge 300mm long</i></p> <p><i>Stainless steel bolt-on hinge 300mm long</i></p>
	<p>BH001</p>	<p><i>Zinc plated bolt-on hinge</i></p>

Design	Code	Specifications
	SSGR-350	<i>Stainless steel grab rail</i> <i>350mm long x 20mm wide</i>
	SSGR-35TB	<i>Stainless steel tube grab rail</i> <i>350mm long x 22mm diameter</i>
 	FRP-DR2212020 FRP-DR2412020 FRP-DR2512020 FRP-DR2712020 FRP-DR2851220 FRP-DR3012020 FRP-DR3214020 FRP-DR3412020 DS20-5000 DST-01	<i>FRP plywood door panels</i> <i>2200 x 1200 x 20mm</i> <i>2400 x 1200 x 20mm</i> <i>2500 x 1200 x 20mm</i> <i>2700 x 1200 x 20mm</i> <i>2850 x 1200 x 20mm</i> <i>3000 x 1200 x 20mm</i> <i>3200 x 1200 x 20mm</i> <i>3200 x 1400 x 20mm</i> <i>3400 x 1200 x 20mm</i> <i>Grey PVC door seal in 5m length</i> <i>Door seal tab</i>

Design	Code	Specifications
	<p>HDS-5000</p>	<p><i>H shaped rubber door seal in the length of 5m.</i></p> <p><i>Dark / light grey color</i></p>
	<p>WTSG2150x1500</p> <p>WTSG1900x1500</p> <p>WTSG1720x1500</p> <p>WTSG1600x1500</p> <p>WTSG1450x1500</p> <p>WTSG1300x1500</p> <p>WTSG1200x1500</p> <p>SGNJ1220X1800</p>	<p><i>Galvanized truck sidegates</i></p> <p><i>2150x1500mm no pegs</i></p> <p><i>1900x1500mm no pegs (7uprights) with pegs</i></p> <p><i>1720x1500mm no pegs (5uprights) with pegs</i></p> <p><i>1600x1500mm no pegs</i></p> <p><i>1450x1500mm no pegs (4uprights) with pegs</i></p> <p><i>1300x1500mm no pegs (4uprights) with pegs</i></p> <p><i>1220x1500mm with pegs (4 uprights)</i></p> <p><i>25x25x1.6mm gal tube frame</i> <i>20x20x1.6mm gal tube uprights</i></p> <p><i>1220x1800mm with reinforcement bar across in the middle</i></p>
	<p>SGP-05</p> <p>SGP-03</p>	<p><i>Gate pocket, 5" coaming 88mm high</i></p> <p><i>Gate pocket , 4" coaming 70mm high</i></p>





Design	Code	Specifications
	SGPG-10	<i>Gate spade, 200x50x10mm</i>
	ZPHB-001	<i>Zinc plated hinge butt with bolt and nut (can also be used to hang sidegates)</i>
	ZPDC-75 SDDC-75	<i>Door Catch</i> <i>Zinc plated 110mm long</i> <i>Stainless steel 93mm long</i>
	Cut to size	<i>Translucent FRP skin suitable for roof panel</i> <i>White color</i> <i>Cut to size as you require</i> <i>60000 x 2490 x 1.5mm</i> <i>60000 x 2490 x 2.5mm</i>



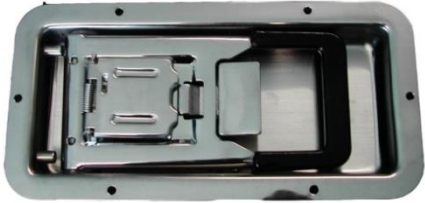

Design	Code	Specifications
	FRP-IR4525026 FRP-IR6425026 FRP-IR7625026 FRP-IR9025026	<p><i>FRP PU insulated roof panel with alum. tube reinforcement at every 600mm apart, 26mm thick</i></p> <p><i>Panel sizes in stock:</i></p> <p><i>4500x2500x26mm</i></p> <p><i>6400x2500x26mm</i></p> <p><i>7600x2500x26mm</i></p> <p><i>9000x2500x26mm</i></p>
	FRP-TR4226020 FRP-TR6425020 FRP-TR7625020	<p><i>FRP honeycomb translucent roof</i></p> <p><i>4200x2260x20mm</i></p> <p><i>6400x2500x20mm</i></p> <p><i>7600x2500x20mm</i></p>
	FRP-HC9028520 FRP-HC7625020 FRP-HC6424420 FRP-HC5524020 FRP-HC4623520 FRP-HC4221520 FRP-HC762527	<p><i>FRP PP honeycomb panels In 20mm thickness or 27mm thickness</i></p> <p><i>Panel sizes in stock:</i></p> <p><i>9000 x 2850 x 20mm</i></p> <p><i>7600 x 2500 x 20mm</i></p> <p><i>6400 x 2440 x 20mm</i></p> <p><i>5500 x 2400 x 20mm</i></p> <p><i>4600 x 2350 x 20mm</i></p> <p><i>4200 x 2150 x 20mm</i></p> <p><i>7600x2500x27mm</i></p>



Design	Code	Specifications
		<i>FRP plywood panels Panel size in stock</i>
	FRP-PW1002520	10000x2500x20mm
	FRP-PW8627020	8600 x 2700x20mm
	FRP-PW7626020	7600 x 2600x20mm
	FRP-PW6424420	6400 x 2440x20mm
	FRP-PW5524020	5500 x 2400x20mm
	FRP-PW4623020	4600 x 2300x20mm
	FRP-PW2524020	2500 x 2400x20mm
FRP-PW6425012	<i>12mm FRP plywood panels are also available</i> 6400x2500x12mm	

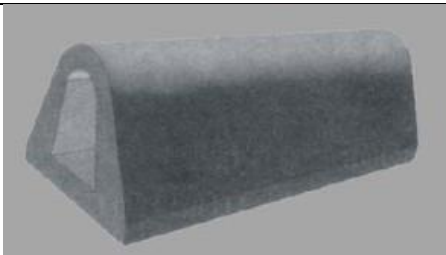

Design	Code	Specifications
		<p><i>FRP PU foam insulated panel in various thickness Panel size in stock</i></p>
	FRP-PU4223550	4250x2350x50mm
	FRP-PU5523050	5500x2300x50mm
	FRP-PU6425050	6400x2500x50mm
	FRP-PU5252170	5250x2100x70mm
	FRP-PU5523570	5500x2350x70mm
	FRP-PU4423100	4400x2300x100mm
	FRP-PU5525100	5500x2500x100mm
	FRP-PU6425100	6400x2500x100mm
FRP-PU2425100	2400x2500x100mm	



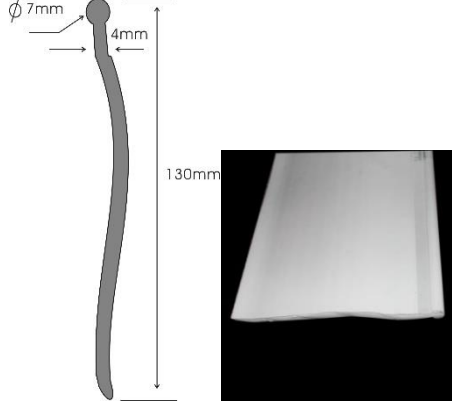

Design	Code	Specifications
 <p>70mm wide frame all over</p> <p>Double side door kit : 1400mm wide x 1800mm high (700mm wide each door) suits 50mm thick panel</p> <p>Complete Stainless Steel Single side door kit : 750mm wide x 1800mm high suits 50mm thick panel</p>	<p>DSK-1800</p> <p>SSK-1800</p> <p>SSK-1600</p>	<p><i>S/steel frame double side door kit 1800 x 1400mm</i></p> <p><i>S/steel frame single side door kit 1800 x 750mm</i></p> <p><i>S/steel frame single side door kit 1600x750mm</i></p>
	<p>DS75-6000</p>	<p><i>Rubber door seal for fridge truck, 75mm thick door panel to suit</i></p>
	<p>RDL-001</p>	<p><i>Roller door over centre lock set with zinc plated hook</i></p> <p><i>Individual key or common key are both available. Please specify when ordering</i></p>

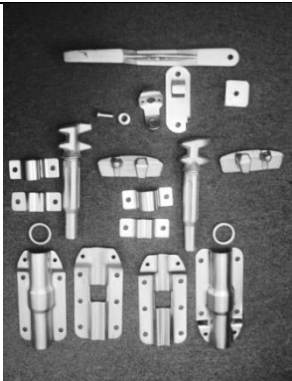

Design	Code	Specifications
	RCL-245	<p><i>Stainless steel recessed door lock set – small 245mm long</i></p> <p><i>Individual key or common key are both available. Please specify when ordering</i></p>
	RCL-340	<p><i>Stainless steel recessed door lock set – large 340mm long</i></p> <p><i>Individual key or common key are both available. Please specify when ordering</i></p>
	ACC100	<p><i>Aluminum corner cap in polished finish</i> <i>100 x 100 x 5mm</i></p>
	FLOV04	<i>#304 Stainless steel buckle</i>
	FLOV17	<i>#304 stainless steel buckle with black webbing strap and black plastic coated tie-tail keeper hook</i>

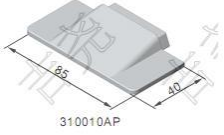

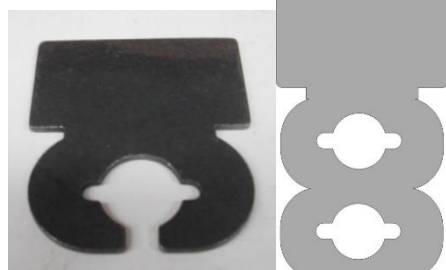

Design	Code	Specifications
	FLOV026	<i>#304 stainless steel buckle with black webbing strap and black plastic coated double J hook</i>
	RBP245-80	<i>Rubber Bumper 245x80mm</i>
	RBF100	<i>Rubber Buffer 100x90mm 2.5mlength</i>
	ZPH75	<i>Zinc plated piano hinge 1.5mm thick . 2.4mlength , open width 75mm, intermediate shaft 5mm with stainless steel pin No holes on the plate</i>
	ZSB160 ZSB190 ZSB210	<i>Zinc plated spring loaded bolt 160mm long x 12mm in diameter 190mm x 12mm 210mm x 12mm</i>

Design	Code	Specifications
	<p>PPMT130B</p> <p>PPMT130W</p>	<p><i>PVC pelmet 130mm long in length of 35m in a box</i></p> <p><i>Black colour</i></p> <p><i>White colour</i></p>
	<p>WT3834</p>	<p><i>Water tank with soap dispenser</i></p> <p><i>380x340x16mm</i></p> <p><i>Hanging straps included</i></p>
	<p>FT2400</p> <p>Larger sizes also available</p>	<p><i>Fridge truck body (complete)</i> <i>2400x1850x1350mm</i></p> <p><i>FRP PU insulated panels</i></p> <p><i>70mm thick panels all over</i></p> <p><i>Other sizes available</i> <i>3050x2100x1920mm</i> <i>3200x2070x2190mm</i> <i>3300x2300x2190mm</i> <i>3900x2260x2180mm</i> <i>4200x2280x2280mm</i> <i>4200x2500x2280mm</i> <i>5500x2500x2280mm</i></p>

Design	Code	Specifications
	<p>SFDT4200</p>	<p><i>Dry freight truck body (flat packed)</i></p> <p><i>4200x2300x2200mm</i> <i>Steel frame + 7mm FRP plywood panel</i></p>
	<p>RVCM-7</p>	<p><i>Rear view camera and monitor kit – 7"LED TFT monitor</i> <i>Either 12v or 24v</i> <i>Camera lens angle : 120 o</i> <i>10 meters long wire</i></p>
	<p>RVCM-4</p>	<p><i>Rear view camera and built-in monitor in rear view mirror (clip on) 4.3" monitor</i></p>
	<p>ZCL-34</p>	<p><i>Heavy duty zinc plated cam locks – 34mm diameter cam</i></p>

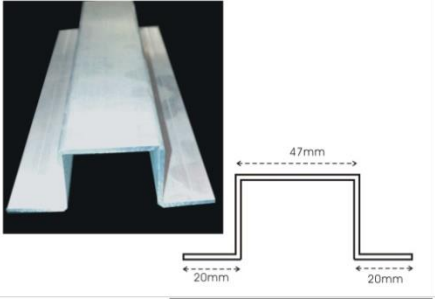

Design	Code	Specifications
	<p>AOTC-01</p>	<p><i>Polished aluminum O-track end cap</i></p>
	<p>RSCT-01L</p> <p>RSCT-01R</p>	<p><i>Galvanized steel rear curtain tensioner – left hand</i></p> <p><i>Galvanized steel rear curtain tensioner – right hand</i></p>
	<p>GB-01</p>	<p><i>Steel gate banana</i></p>
	<p>LLBS01</p> <p>LLBD01</p>	<p><i>LED Light bracket – single 3mm steel plate with anti-rust coating</i></p> <p><i>LED light bracket - double</i></p>
	<p>DFSK01</p> <p>3mm thick steel frame with prime paint in grey color</p>	<p><i>FRP side door kit for dry freight truck body with galvanized hinges and dish lock</i></p> <p><i>1800 x 1200mm</i></p> <p><i>2100 x 1200mm</i></p> <p><i>2400 x 1200mm</i></p>

Design	Code	Specifications
	<p>FRD2850</p> <p>FRD3200 Complete with cam locks and door seals</p>	<p><i>Aluminum flush rear door in mill finish with FRP honeycomb door panel</i></p> <p>2850x1200mm</p> <p>3200x1200mm</p>
	<p>LLPL1030</p> <p>ADR approved</p>	<p><i>LED license plate lamp</i> <i>Multi-voltage</i></p>
	<p>PR55W</p> <p>PR55A</p> <p>PR55R</p> <p>ADR approved</p>	<p><i>Self-adhesive reflector</i> <i>White color</i></p> <p><i>Amber color</i></p> <p><i>Red color</i></p>
	<p>LCL6035W LCL6035A LCL6035R LCL6035AR</p> <p>ADR approved</p>	<p><i>Led Clearance light</i> <i>60mm x 35mm</i></p> <p><i>White</i> <i>Amber</i> <i>Red</i> <i>Amber / Red</i></p>

Design	Code	Specifications
	DSL-01	<i>Galvanized steel camlock</i>
	LSL6-18	<i>LED spotlight , LED power 18W , multi-voltage. Waterproof Size : 118x116x48mm</i>
	ARB-2500	<i>Aluminum roof bow in the length of 2.5m long, 2mm thick, 87mm wide. Mill finish</i>
	RFG-2	<i>Rollers for hanging gates 45mm diameter roller</i>

Design	Code	Specifications
	TP-01	<i>Steel gate hook for tipper truck, 20mm thick plate</i>
	TP-02	<i>Steel plate for tipper truck, 5mm thick</i>
	ZCW160	<i>Zinc plated clip on winch with 9mtr. long webbing strap and hook LC-2500kg</i>
	HDT-Lock	<i>Heavy duty T-handle lock. Powder-coated in black</i>

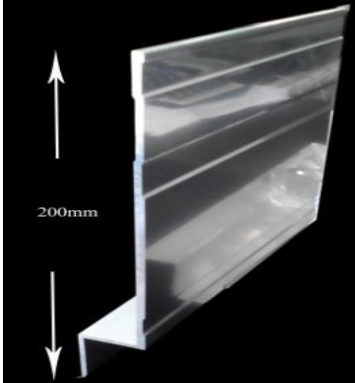
Design	Code	Specifications
	ASPF-2512	<i>Plywood floor with anti-slip film.</i> <i>2500x1220x18mm</i>
	CTL-232	<i>Container twist lock with casing</i>
	TL-170	<i>Zinc plated toggle fastener.</i> <i>170mm long</i>
	TL-125	<i>Zinc plated toggle fastener with plastic coated handle 120mm long</i>
	AL-7312	<i>Zinc plated anti-luce</i> <i>73cm long , 12mm diameter</i>
	SSBT-08 ZBT-08	<i>Stainless steel 8mm hub bolts to suit 20mm thick panels</i> <i>Zinc plated hub bolts 35mm or 22mm dia</i>
	AAGL100	<i>Aluminum angle extrusion with polished finish</i> <i>100x4mm</i> <i>6500mm /length</i>

Design	Code	Specifications
	<p>ABMG200</p>	<p><i>Aluminum bottom guard extrusion with polished finish, 200x4mm 6500mm / length</i></p>
	<p>ARFT557</p> <p><u>*NOT TO BE USED FOR LOAD RESTRAINT CURTAINS.</u></p>	<p><i>Aluminum roof track</i></p> <p><i>6400mm / length</i></p> <p><i>7600mm / length</i></p> <p><i>9300mm / length</i></p>



**WE'LL KEEP YOU ON
THE ROAD**

National Branch Network

Adelaide, South Australia

70 Wingfield Road, Wingfield SA 5013

Brisbane, Queensland

81 Kempster Street, Sandgate QLD 4017

Gold Coast, Queensland

2/18 Expansion Street, Molendinar QLD 4214

Melbourne, Victoria

1/39A Scammel Street, Campbellfield VIC 3061

Newcastle, New South Wales

1/6 Huntingdale Drive Thornton NSW 2322

Sydney, New South Wales

19 Memorial Avenue, Ingleburn NSW 2565

Townsville, Queensland

1/585 Ingham Road, Mount St John QLD 4818